



Clipsal Motion and Occupancy Sensors

 **CLIPSAL**[™]

The sixth sense for peace of mind
energy efficiency.

clipsal.com/sensors

Life Is  On

Schneider
 Electric

Introduction

Motion and occupancy sensors help to provide peace of mind with added security, energy efficiency and true 'hands-free' convenience.

A motion sensor is a lighting control device that detects movement, such as a person walking into a space. Once detection occurs loads are automatically switched on and are then switched off after a preset amount of time. The Clipsal Infrascan® range is the benchmark and preferred choice for motion sensors due to their reliability and simplicity of installation and operation.

Occupancy sensors detect the occupancy of a space, utilising highly accurate detection technology. Occupancy sensors detect fine motions such as the typing of a keyboard, which trigger the load of the sensor.

Clipsal offers a wide range of motion and occupancy sensors for use in residential and commercial applications. This range encompasses standalone sensors and system integrated sensors to provide diverse opportunities to address all residential and commercial energy management needs. Different technologies including Passive Infrared (PIR), Ultrasonic (US) and Microwave provide appropriate solutions for different environments.



Contents

Infrascan® Sensors

750WPR5 – Outdoor	4
751R – Corner Mount	5
753R – 360° Flush Mount	6
753SSR – 360° Surface Mount	8

Iconic Sensor

41EPIRM-TN – 360° wall switch mech	9
------------------------------------	---

Commercial Sensors

752IR2RC – Wide Range	10
752HF2RC – Microwave	11
752DALI Series – DALI Output	12
752/CD Series – Dual Tech	13

C-Bus® Sensors

5750 Series – Outdoor	15
5751 Series – Corner Mount	16
5753 Series – 360° Flush Mount	17
5754 Series – 360° Surface Mount	18

DALIcontrol Sensors

DCDALMS360 – 360° Flush Mount	19
DCDAL31MOD – 30 Series Mechanism	20

Infrascan® Sensors

750WPR5-GY & 750WPR5-BK Outdoor Sensor, 3 Wire



The 750WPR5 is Clipsal's flagship sensor, well known for its robustness, ease of install and simple functionality. The Infrascan helps to provide added peace of mind around the home or business. Designed for Australia's harsh conditions with a UV protected enclosure and an IP66 rating, the sensor is completely dust and waterproof allowing for installation in outdoor areas. Ideal for garages or carparks.

Features

- 110° field of view, covering up to 18 metres from unit
- PIR sensor technology for precise outdoor motion detection
- Flat, multi segmented lens divides 'field of view' into 48 zones – reduces number of 'dead zones'
- Wall or ceiling mounted – for flexibility in installation positioning
- Robust UV protected lens and enclosure and unique design features for true IP66 rating
- 8hr manual override for added flexibility.
- Suitable for residential and commercial applications

Specifications

750WPR5-GY, 750WPR5-BK	
Supply	AC 200 – 265V, 50Hz
Output	10A, 300W LED
Time Setting	5 seconds – 20 minutes
IP Rating	IP66
Wiring	3 Wire

See data sheet on Clipsal.com for full specifications.
Available in grey or black - colour codes: -GY and -BK.

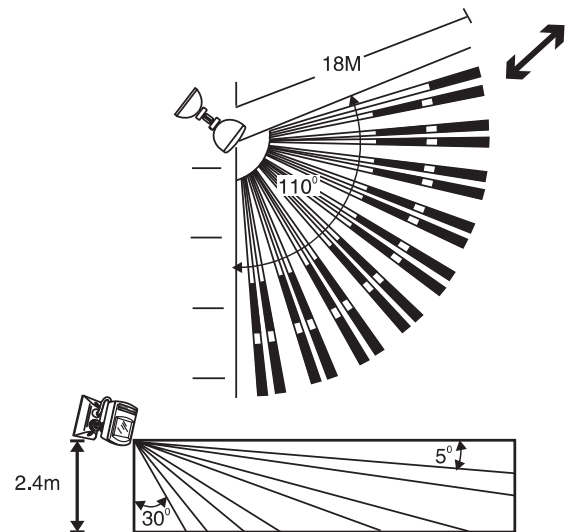



Scanned Area - Horizontal Plane

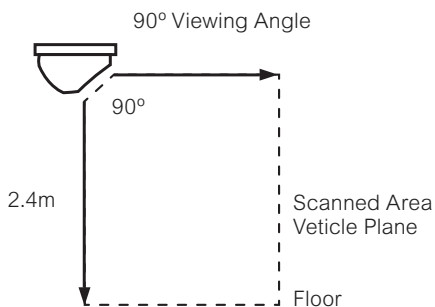
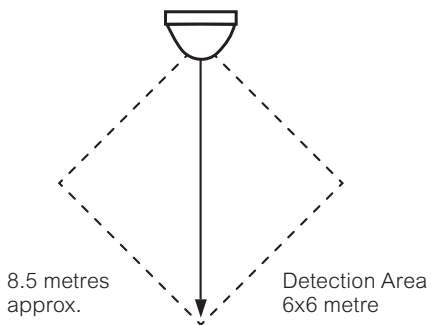

751R-WE Corner Mount Sensor, 3 Wire

The 751R provides 90° of detection, designed for installation in corners. With precise PIR detection and robust design, the sensor is ideal for applications in bathrooms, walk in robes and home offices.

Features

- 90° viewing angle from sensor head, detection range 6 x 6 metres, at 2.3 metre mounting height
- PIR sensor technology for precise indoor motion detection
- Designed for room corner mounting
- Sensor rotatable by 120° – easy adjusting of sensing zone
- Simple installation for faster fit off
- Three wire units can be paralleled to control a single load from multiple sensors
- Suitable for residential and commercial applications

Specifications

751R-WE	
Supply	AC 200 – 265V, 50Hz
Output	10A
Time Setting	5 seconds to 20 minutes
IP Rating	IP20
Wiring	3 Wire

See data sheet on Clipsal.com for full specifications.

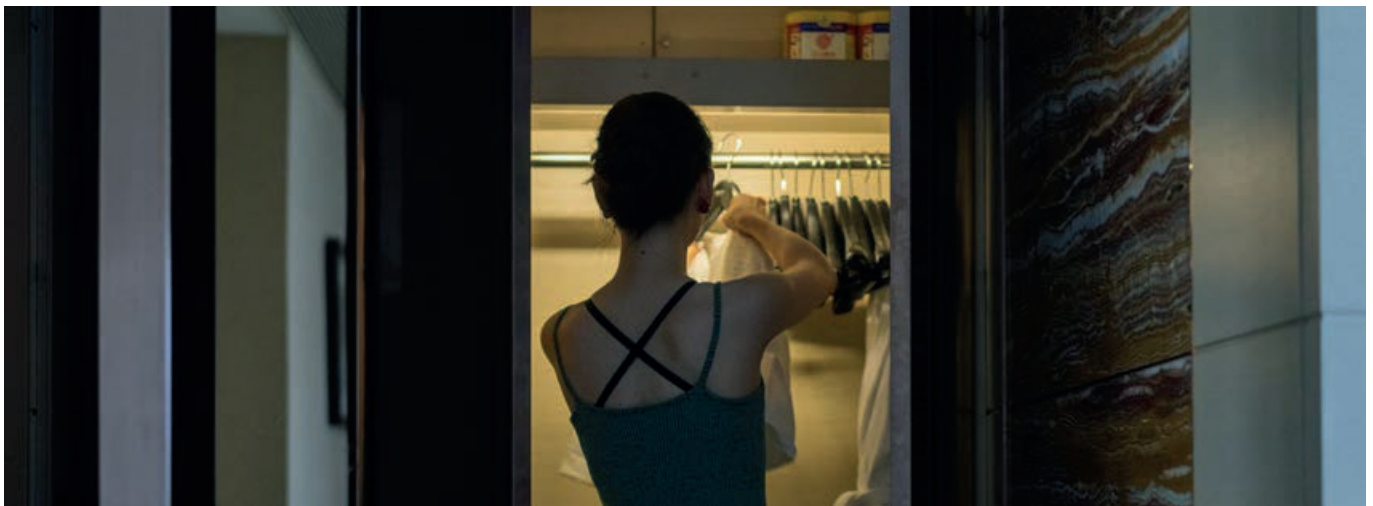

753R-WE 360° Flush Mount Sensor, 3 Wire

The 753R utilises an advanced quad element sensor array to allow instantaneous detection. Appearance wise, the 753 is a slimline, fully recessed mounting facility, making it one of the most sleek and unobtrusive 360° sensors available. Ideal for applications in bathrooms, walk in robes, pantries and office areas.

Features

- 360° field of view, with detection range 10 metre diameter, at 2.4 metre mounting height
- PIR sensor technology for precise indoor motion detection
- Unobtrusive flush mount design
- Advanced quad element sensor
- Recessed ceiling mounted
- Robust design and easy to install with large wiring terminals
- 10A load rating for use with a variety of applications including LED lighting
- Suitable for residential and commercial applications

Specifications

753R-WE	
Supply	AC 200 – 265V, 50Hz
Output	10AX, 300W LED
Time Setting	5 seconds to 20 minutes
IP Rating	IP20
Wiring	3 Wire

See data sheet on Clipsal.com for full specifications.

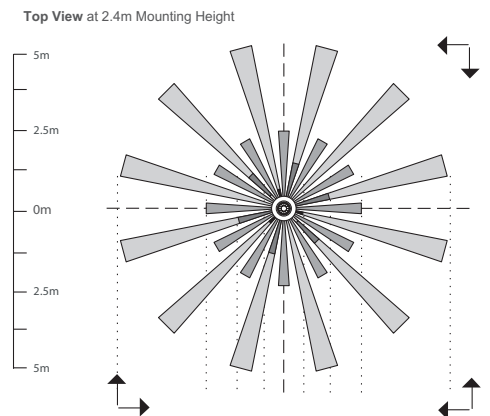



753CF1 360° Flush Mount Sensor, 1 Output

753CF2 360° Flush Mount Sensor, 2 Outputs

The 360° PIR Sensor is low profile, allowing for an unobtrusive addition to the room, while maximising convenience and energy saving. With its simple installation and flush mounting, the sensor is ideal to address basic sensor requirements, including toilets, walk in robes, pantries and small offices.

Features

- 360° field of view, with detection range of 3.5 metre radius, and up to 7 metre if tilted with gimble
- Small, attractive flush sensor with unobtrusive design
- Gimbled head for range adjustment and easy access to trim pots
- Two models available - Single load (for lighting) and dual load (for lighting and HVAC)
- Quick and easy settings for lux level and time on both outputs
- Consists of sensor and power box to allow for low ceiling spaces
- Lens mask provided to shield unwanted detection zones
- Suitable for residential and small commercial applications

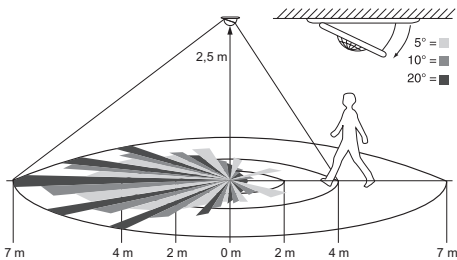
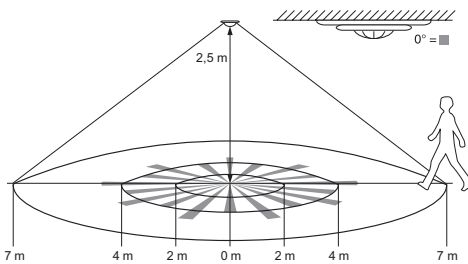

Specifications

	753CF1	753CF2
Supply	AC 220-240 V, 50/60 Hz	
Output Ratings	LED: max. 100 W Incandescent lamps: max. 1000 W	Output 1: (Switched Active) LED lamps: 100 W Incandescent lamps 240V a.c.: 2000 W Output 2: (Voltage Free Relay) AC 250 V, 5 A resistive Motor: 100 W
Time Setting	30s to 30 min	Time 1 (Output 1): 30s to 30 min Time 2 (Output 2): 10s to 15 min
IP Rating	IP20	

See data sheet on Clipsal.com for full specifications.



CPL753SSR-WE 360° Surface Mount Sensor

The CPL753SSR provides high resolution PIR detection over a wide area of 24 metres diameter. Equipped with four pyro sensors, the sensor is capable of detecting fine movements, such as a finger moving, within its inner diameter as well as larger movements in its outer detection area. Ideal for indoor or areas such as open area living, offices, car parks, garages, carports or outside spaces.



Features

- 360° field of view, with detection range 24 metre diameter
- Advanced resolution with four PIR pyro sensors for detection of small movements
- Ceiling surface mounted with inbuilt wiring box
- Inbuilt 4 hour manual override ON feature
- 1416 switching zones and 10 detection levels for precise detection
- Lens mask provided to shield unwanted detection zones

Specifications

CPL753SSR-WE	
Supply	240V 50Hz
Output	ELV: 1000W Max Fluoro: 1000W Max LED: 8x LED drivers Max Incandescent / 240V halogen: 2400W Max
Time Setting	5 seconds – 15 minutes Pulse Mode (approx. 2 seconds)
IP Rating	IP54

See data sheet on Clipsal.com for full specifications.

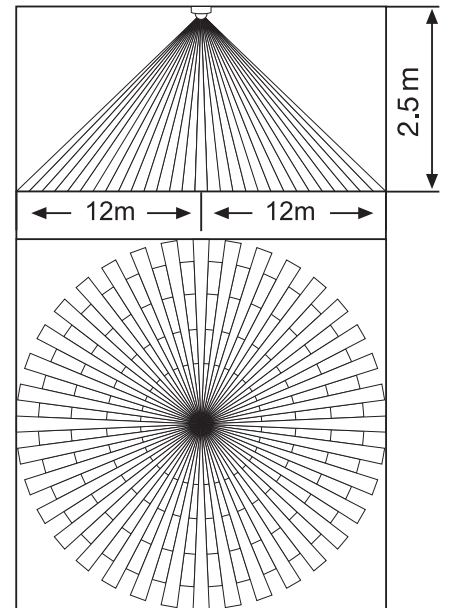

Clipsal Iconic™ Sensor

Clipsal Iconic™ Sensor

The Iconic sensor mechanism is a wall plate mounted PIR motion sensor providing 100° detection of movement up to 5m and control of loads up to 150W LED. The simple front facing trimpots and modular form factor provides simple and flexible installation and setup. With the convenience of hands free lighting control and benefits of saving energy usage, the Iconic PIR sensor is great for multiple areas around the home such as entrances, walk-in-pantries, walk-in-robos, hallway, stairs and more.



Features

- Modular mechanism for Clipsal Iconic wall plates
- 100° detection up to 5m
- 150W LED load rating
- Simple installation and adjustment with front facing trimpots
- Lens Zone mask to block any unwanted detection zones

Specifications

41EPIRM-TN	
Supply	240V, 50Hz
Output	150W LED, 750W Incand.
Time Setting	10 seconds – 15 minutes
IP Rating	IP20
Wiring	3-wire

See data sheet on Clipsal.com for full specifications.

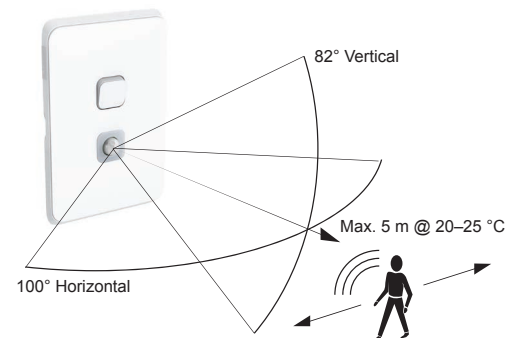



Commercial Sensors

752IR2RC Wide Range Sensor

The 752IR2RC is a wide range ceiling mounted sensor with dual output for lighting and HVAC control. The sensor detects movement over 30 metres, providing high sensitivity within the minor and major motion zones. Ideal for use in large open areas, lobbies, corridors, offices, libraries, conference rooms and reception areas.

Features

- 360° field of view, with detection range 30 metre diameter
- PIR sensor technology for precise indoor detection
- Switching of two outputs (e.g. light and HVAC) with two independent adjustable timers
- External triggering via pushbutton
- Configurable timer options including pulse output to trigger external relays
- Optional wireless remote control (752RC/IR) for ease of configuration
- Suitable for flush or surface mounting with both bases included

Side View

- Major Motion
- Minor Motion

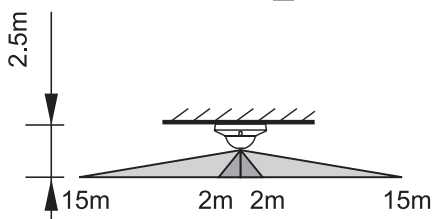

Top View

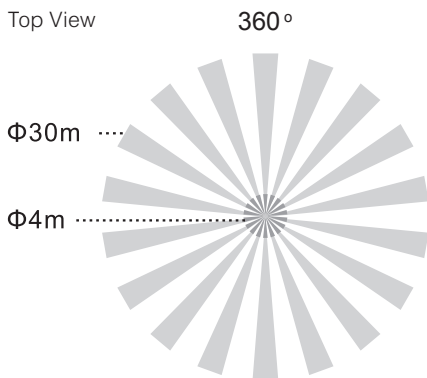

Specifications

752IR2RC	
Supply	AC 220–240 V, 50/60 Hz
Output	Output 1: (Switched Active): LED lamps: 100 W Incandescent lamps: 2000 W Output 2: (Voltage Free Relay): AC 250 V, 5 A resistive Motor: 100 W
Time Setting	Time 1 (output 1): from approx. 10 s to approx. 30 min Time 2 (output 2): from approx. 10 s to approx. 60 min
IP Rating	IP40 (flush mount) or IP42 (surface mount)

See data sheet on Clipsal.com for full specifications.



752HF2RC Microwave Sensor

The 752HF2RC is an occupancy detector with an integrated High Frequency Doppler Effect Sensor providing high sensitivity to small motion, suitable for many commercial applications. It allows excellent detection ability for heights reaching 10 metres and through non-metallic materials. Ideal for high ceilings, foyers, above ceiling spaces, factory high bay applications and areas where detection without direct view to movement is needed and where temperature influences might cause false detection with PIR sensors, such as data centres.



Features

- High frequency technology for advanced occupancy detection
- Strong detection at significant heights – 10 metre diameter at height of 10 metres
- High performance sensing – dust, temperature, light, airflow, sound or vibration will not affect performance
- Sensor penetrates non-metallic materials (e.g. wood, glass, thin brick) – can detect motion in areas where direct view is unavailable
- Detection range 14 metre diameter, at an installation height of 2.5 metres
- Optional wireless remote control (752RC/HF) for ease of configuration
- 360° field of view
- Integrated light level sensor - set desired thresholds for switching on the light
- Suitable for flush or surface mounting with both bases included

Specifications

752HF2RC	
Supply	AC 220–240 V, 50/60 Hz
Output	Output 1: (Switched Active): LED lamps: 100 W Incandescent lamps: 2000 W Output 2: (Voltage Free Relay): AC 250 V, 5 A resistive Motor: 100 W
Time Setting	Time 1 (output 1): 10s to 30 min Time 2 (output 2): 10s to 60 min
IP Rating	IP40 (flush mount) or IP42 (surface mount)

See data sheet on Clipsal.com for full specifications.

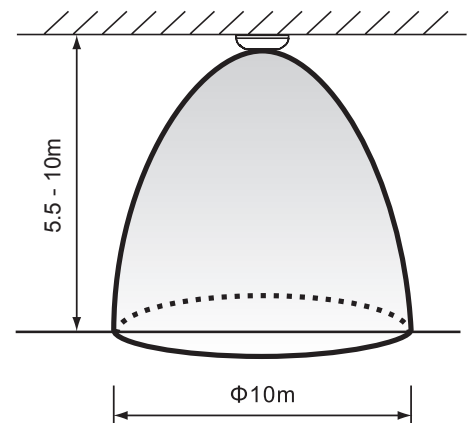
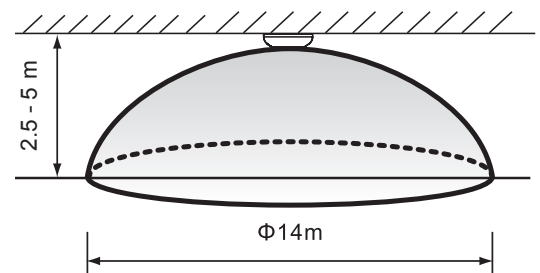

752DALIRC DALI Output Master Sensor

752DALIS DALI Output Slave Sensor



The 240V powered stand-alone DALI Output Sensors provide occupancy detection with multi-functional capabilities including switching on and off and dimming of end point DALI fittings, offering comfort and convenience as well as energy saving benefits. The DALI Slave PIR Sensor provides detection range extension for the Master Sensor. Ideal for lobbies, class rooms, offices and conference rooms.

Side View

- Major Motion
- Minor Motion

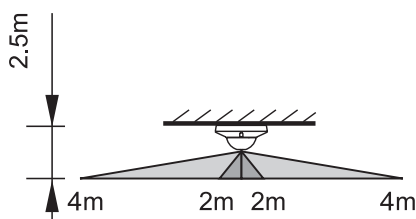

Features

- PIR sensor technology for precise motion and occupancy detection
- 360° field of view, with detection range of 8 metre diameter
- Switching and dimming of DALI electronic ballasts
- Daylight harvesting for constant brightness management
- 2 independent DALI broadcast outputs on the Master Sensor
- Detection range extended by up to 10 Slave Sensors
- Input for external switches for manual override
- Optional wireless remote control (752RC/DALI) for easy configuration
- Suitable for flush or surface mounting with both bases included

Top View

360°

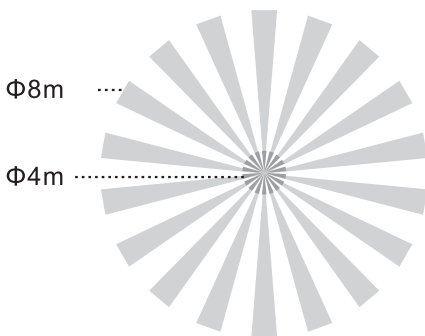

Specifications

	752DALIRC	752DALIS
Supply	AC 220–240V, 50/60Hz	
Output	DA1 and DA2 (per zone): Max. 25 DALI ballasts 16V d.c. , 50mA max	Managed by Master
Time Setting	1 min to 60 min	Managed by Master
Standby Mode	Options: Output level: 10%, 20%, 30% or OFF Time settings: 5 , 10, 15 min or infinity.	N/A
IP Rating	IP40 (Flush mount) or IP42 (surface mount)	

See data sheet on Clipsal.com for full specifications.



752CD1RC Dual Tech Sensor, 1 Output

752CD2RC Dual Tech Sensor, 2 Output

The Dual Tech Occupancy Sensors utilise PIR and Ultrasonic technologies to provide highly sensitive yet accurate detection. The sensors detect minor and major movement, while also screening out nuisance or false triggering. Providing logic functions to enable optimal detection performance through the entire coverage area, dual technology sensors are equipped to deal with commercial applications such as open office areas, conference rooms or class rooms.

Features

- Highly effective detection combining Ultrasonic technology (for high sensitivity of motion) with PIR (to combat false triggering)
- 360° field of view, with two detection zones
- Detects minor movements such as typing or reading
- 4 detection options: PIR + US, PIR only, US only, PIR or US
- Optional wireless remote control (752RC/CD) for easy configuration
- Single channel model for control of lighting and dual channel model for simultaneous control of lighting and HVAC
- Suitable for flush or surface mounting with both bases included

Specifications

	752/CD1RC	752/CD2RC
Supply	AC 240V~ ±10% 50/60Hz	
Output	(Switched Active): LED lamps: 300W Incandescent: 2000 W	Output 1 (Switched Active): LED lamps: 600W Incandescent: 2300 W Output 2 (Voltage Free Relay): 5A for < 250V AC resistive, 5A for < 30V DC
Time Setting	5 sec - 30 min	Time 1 (Output 1): 5 sec – 30 min Time 2 (Output 2): 10 sec – 60 min
IP Rating	IP20	

See data sheet on Clipsal.com for full specifications.

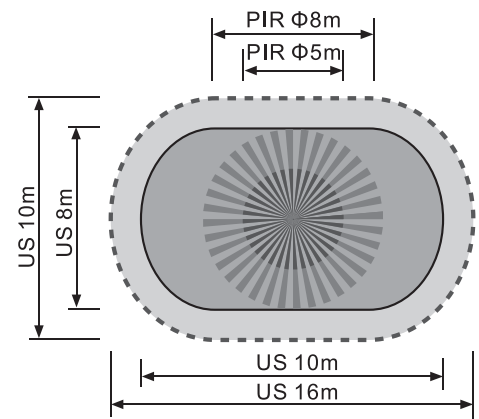

- PIR Minor Motion
- PIR Major Motion
- Ultrasonic Minor Motion
- Ultrasonic Major Motion



C-Bus

C-Bus is a micro-processor controlled wiring system for lighting control and energy management. In buildings, it allows facility managers and integrators to configure an area or zone as required; such as automatically switching lights off or adjusting light intensity in accordance with natural light levels, plus integrate with the BMS for building wide control. In residential environments, C-Bus offers a total luxury package, controlling multiple devices while integrating with 3rd party systems to achieve a customised solution for the smart home.

With C-Bus, you can achieve an environment of comfort, convenience, security and energy efficiency in any of the following applications:

Residential

- Homes
- Apartments

Commercial

- Office
- Warehouse and Industrial
- Education and Health
- Sporting Facilities
- Hotels and Accommodation
- Retail
- Hospitality and Entertainment

Adding sensors make an environment smarter and more efficient. C-Bus sensors allow elements such as presence, occupancy and vacancy to be detected and in turn, control loads or functions plus adjust lighting levels to alter the environment as required.



5750WPL-GY C-Bus Outdoor Sensor

Advanced C-Bus PIR sensor suitable for both outdoor commercial and residential applications within a C-Bus system solution.

Features

- 110° field of view with four detection zones – long range 18 metres, intermediate range 8 metres, short range 4 metres and ultra short range 1.2 metres at 2.4 metres mounting height
- PIR sensor technology for precise motion detection
- Wall or ceiling mounted – for flexibility in installation positioning
- Inbuilt light level sensor supporting a Sunset Switch program
- Capable of controlling up to 4 C-Bus group addresses
- Dual element detectors minimise false triggering
- Features light threshold and PIR sensitivity adjustments on the unit
- Programmable using C-Bus Toolkit commissioning software, offering advanced system features

Specifications

5750WPL-GY	
Supply	Powered by C-Bus
Output	C-Bus
Time Setting	1 second to 18 hours
IP Rating	IP66

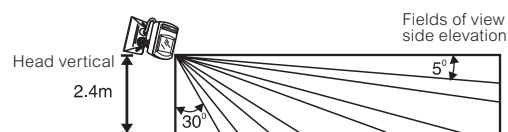
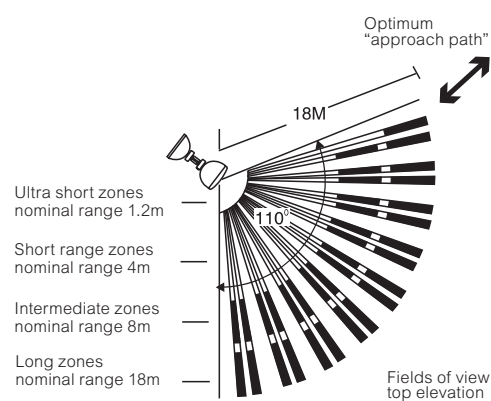

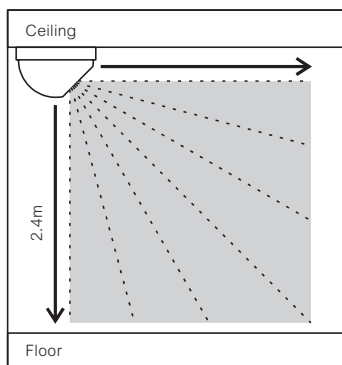
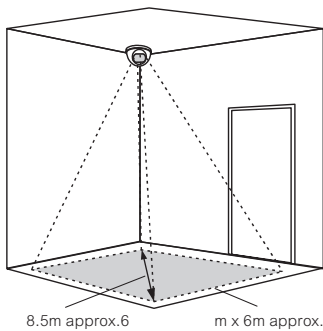

5751L-WE C-Bus Corner Mount Sensor

Advanced corner mount C-Bus PIR sensor suitable for both commercial and residential applications within a C-Bus system solution.

Features

- 90° field of view, with detection range 6 x 6 metre, at 2.4 metre mounting height
- PIR sensor technology for presence and occupancy detection
- Surface mount for corner room installation
- Inbuilt light level sensor supporting a Sunset Switch program
- Capable of controlling up to 4 C-Bus group addresses
- Dual element detectors minimise false triggering
- Features light threshold and PIR sensitivity adjustments on the unit
- Programmable using C-Bus Toolkit commissioning software, offering advanced system features

Specifications

5751L-WE	
Supply	Powered by C-Bus
Output	C-Bus
Time Setting	1 second to 18 hours
IP Rating	Suitable for indoor use



5753L C-Bus 360° Flush Mount Sensor

5753PEIRL C-Bus 360° Flush Mount, Multi Sensor

Advanced C-Bus sensor including PIR sensor, Light Level sensor and an Infrared receiver (5753PEIRL only). Suitable for both commercial and residential applications within a C-Bus system solution.

Features

- 360° field of view, with detection range 15 metre diameter, at 2.4 metre mounting height
- PIR sensor technology for precise motion and occupancy detection
- Light level sensor for light level maintenance (daylight harvesting)
- Flush mount for unobtrusive appearance
- Features a Sunset Switch program
- Capable of controlling up to 8 C-Bus group addresses or 8 C-Bus scenes
- Supports corridor linking for commercial building applications
- Dual element detectors minimise false triggering
- Programmable using C-Bus Toolkit commissioning software, offering advanced system features

Additional features of 5753PEIRL

- IR receiver for C-Bus control from a handheld remote

Specifications

	5753L	5753PEIRL
Supply	Powered by C-Bus	
Output	C-Bus	
Time Setting	1 second to 18 hours	
IP Rating	Suitable for indoor use	

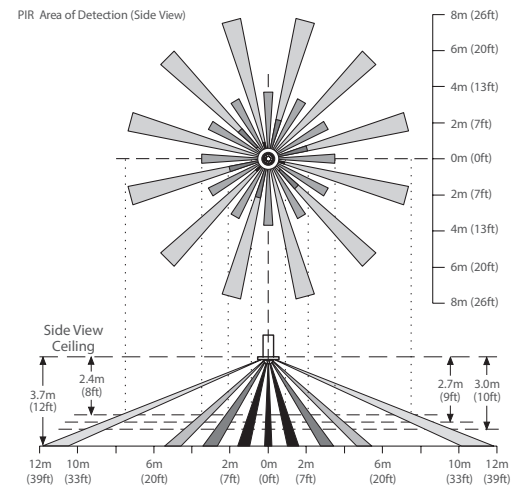

5754ODPE C-Bus 360° Surface Mount Sensor

5754ODPEIR C-Bus 360° Surface Mount, Multi Sensor



Advanced C-Bus sensor including PIR sensor, Light Level sensor and an Infrared receiver (5754ODPEIR only). Suitable for both commercial and residential applications within a C-Bus system solution.

Features

- 360° field of view, with detection range of 10 metre diameter, at 2.4 metre mounting height
- PIR sensor technology for precise indoor motion and occupancy detection
- Light level sensor for light level maintenance (daylight harvesting)
- Surface mount for quick mounting onto solid surface such as masonry/slab or wood
- Low-profile surface mount design – extends only 33mm from the mounting surface
- Features a Sunset Switch program
- Capable of controlling up to 8 C-Bus group addresses or 8 C-Bus scenes
- Supports corridor linking for commercial building applications
- Dual element detectors minimise false triggering
- Features light threshold & PIR sensitivity adjustments on the unit
- Programmable using C-Bus Toolkit commissioning software, offering advanced system features

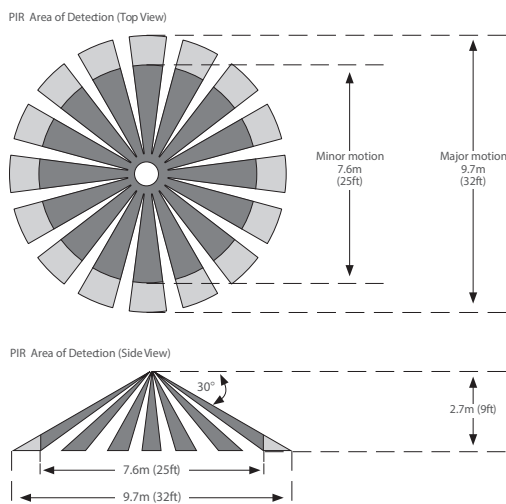

Additional features of 5754ODPEIR

- IR receiver for C-Bus control from a handheld remote

Specifications

	5754ODPE	5754ODPEIR
Supply		Powered by C-Bus
Output		C-Bus
Time Setting		1 second to 18 hours
IP Rating		Suitable for indoor use



DALIcontrol

DALIcontrol is a lighting control system built on the DALI (Digital Addressable Lighting Interface) international standard providing a single interface for all electronic control gear (light sources) and electronic control devices (lighting controllers) and is perfectly tailored to control office lighting in multi-storey buildings. The DALIcontrol Native, Simple and Advanced solutions provide the ability to scale a lighting system from a room, to a floor, to a complete building and beyond. Each DALIcontrol system can utilise a mixture of DALI devices which can include DALIcontrol switches and sensors plus DALIcontrol Line Controllers to control lighting and exit and emergency fittings on DALI lines.

DALIcontrol sensors are an important component for intelligent lighting control within a DALI system and make an environment smarter and more efficient. DALIcontrol sensors allow elements such as presence, occupancy and vacancy to be detected and in turn, control loads or functions plus adjust lighting levels to alter the environment as required.



DCDALMS360 DALIcontrol 360° Flush Mount Motion Sensor

Advanced DALIcontrol motion sensor suitable for commercial lighting control applications within a DALI system solution.

Features

- 360° field of view, with detection range of 10 metre diameter, at 2.4 metre mounting height
- PIR sensor technology for precise motion and occupancy detection
- Light level sensor for light level maintenance (daylight harvesting)
- Flush mount for unobtrusive addition to room
- Quickly mounts onto ceiling tiles or cavity ceilings
- Supports linked control of PIR or Lux sensing for the same targets
- Configurable on and off actions
- Up to 4 switchable profiles
- Features light threshold and PIR sensitivity adjustments on the unit
- Programmable using DALIBuildings commissioning software, offering advanced system features

Specifications

DCDALMS360	
Supply	Powered by DALI
Output	DALI
Time Setting	1 second to 255 minutes
IP Rating	Suitable for indoor use

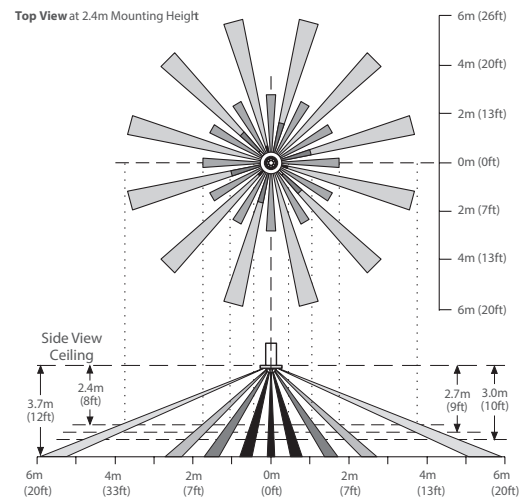



DCDAL31MOD DALIcontrol 30 Series Mechanism Motion Sensor

Advanced DALIcontrol motion sensor suitable for commercial lighting control applications within a DALI system solution.

Features

- 120° field of view, with detection range 5 metre diameter, at 2.7 metre mounting height
- PIR sensor technology for precise motion and occupancy detection
- 30M format – suits Clipsal gridplate or DALIcontrol housing fitment
- Detection range typically 5 metres from the lens, when installed in wall
- Configurable on and off actions
- Up to 4 switchable profiles
- Programmable using DALIBuildings commissioning software, offering advanced system features

Specifications

DCDAL31MOD	
Supply	Powered by DALI
Output	DALI
Time Setting	1 second to 255 minutes
IP Rating	Suitable for indoor use

Top View at 2.7m Mounting Height

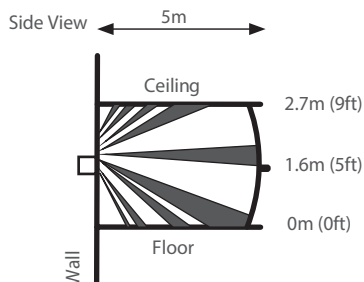
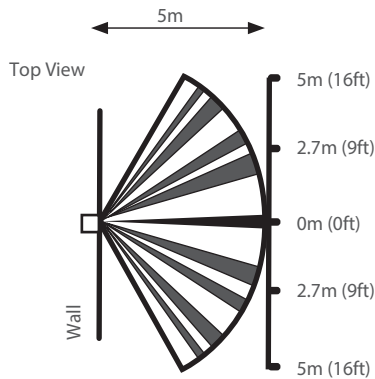
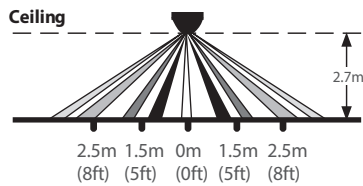
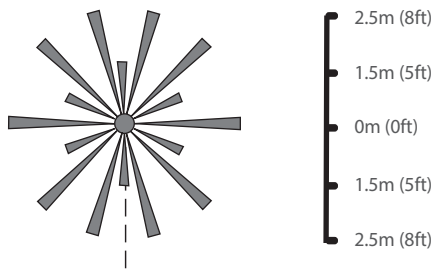

Clipsal Lighting and Sensors Solutions

Sensor technology has always been a great way to improve performance and lifespan of lighting in any installation, as well as reducing running costs by only having the light on when it's needed.

When you combine this with Clipsal's range of energy efficient LED lighting you start to create a solution that can truly bring maximum benefits into your building.

As with our large range of sensor products, our broad range of luminaires provides an option for almost every one of your lighting needs. With products suited for residential, commercial and industrial applications we take care to ensure our offers can withstand the large inrush currents and harsh running conditions LEDs can create. Testing both sensor and luminaire together gives you confidence that when you put the combination into your installation you can rest easy it is Clipsal tested and backed to perform.

Floodlighting

Whether it be lighting a large surrounding area of a commercial building or subtly illuminating the outdoor living space at home, Clipsal has a range of LED Floodlights to suit your needs. From our high powered FLH series that can offer lighting in public places to our sleek and low profile FLS series with its softer light output that is more suitable for the home alfresco area, our Floodlights allow you to continue to live even when the sun goes down.

These lights increase in functionality when you add one of our outdoor sensor products like a 750WPR5, with its leading range and sensing technology. This means the lights are on only when you are in the area and wait till you leave it before turning them off.



TPFLS Series



Exterior Batten Range

Excellent for commercial and residential applications, schools, car parks, security purposes, public buildings, carports and garages these fittings are manufactured with a robust construction that shields the high output LED technology to maintain maximum light output and lamp life. Designed to provide high levels of illumination under adverse conditions where reliable performance is crucial, the polycarbonate diffuser provides not only resistance from external impact but an even distribution of light.

In commercial security installations, pairing these fittings with our 5754ODPE allows the control of these luminaires do be performed automatically as the natural light fades and artificial illuminance is required



TPTUFF Series



TPWP Series



Downlights

LED Downlights are suitable for multiple illumination applications from residential to commercial buildings. The slightly recessed frosted diffuser ensures reduced glare and soft glow output. Warmer light output is great for areas that experience high traffic and entertainment, while the cooler output versions are great for working environments that require maximum illumination. The TPDL1C1 Series comes with an integrated colour temperature selector switch enabling the choice of 3000K, 4000K and 6000K outputs to suit multiple applications and decor.

Adding an internal sensor with the appropriate sensing range and direction allows for these lights to be activated when you approach from a certain direction or only when you're standing directly underneath. Selecting the right one is up to you.



TPDL Series







Standalone 240V Selection Guide

					
	PIR Motion Sensor Surface Mount	PIR Motion Sensor Flush Mount	PIR Motion Sensor Corner Mount	PIR Motion Sensor Outdoor	PIR Motion Sensor iconic mech
Cat Number	CPL753SSR	753R-WE	751R-WE	750WPR5-GY 750WPR5-BK	41EPIRM-TN
Standalone or System Sensor	Standalone	Standalone	Standalone	Standalone	Standalone
Supply Voltage	240v, 50Hz	240V, 50Hz	240V, 50Hz	240V, 50Hz	240V, 50Hz
Design	3-Wire	3-Wire	3-Wire	3-Wire	3-Wire
Special Feature	High Sensitivity	Unobstrusive robust design	Room corner installation	High robustness	Modular mechanism
Sensor Technology	PIR (4 pyro sensors)	PIR	PIR	PIR	PIR
IP Rating	IP54	IP20	IP20	IP66	IP20
Mounting	Ceiling, surface	Recessed Ceiling	Corner, ceiling, surface	Wall, Ceiling	Wall Plate (Iconic)
Detection Angle	360°	360°	90°	110°	100° Hor / 82° Ver
Detection Range	Ø 24m at H = 2.5m	Ø 10m at H = 2.4m	6 x 6 m	18 m	5 m
Timer Setting	5 sec – 15 min Pulse mode	5 sec – 20 min	5 sec – 20 min	5 sec – 20 min	10 sec – 15 min
Light Level Sensor	YES	YES	YES	YES	YES
Material Penetration	NO	NO	NO	NO	NO
Inbuilt Manual Override	YES (load on for 4 hrs)	NO (use separate switch to load)	NO (use separate switch to load)	YES (load on for 8 hrs)	NO (use separate switch to load)
IR Remote Control	NO	NO	NO	NO	NO
Connectivity (Voltage free output for C-Bus or HRC connection)	NO	NO	NO	NO	NO
Output Ratings	240V~10A, 300W LED	240V ~ 10AX, 300W LED	240V~10A	240V ~ 10A, 300W LED	240V ~ 300W LED, 750w incand
Warranty	3 year	2 year	2 year	5 year	2 year
Suggested Application	Car parks, garages	Homes, small offices	Toilets, bathrooms	Car parks, entrance ways, garage doors, driveways, porches, backyards	Walk in robe, pantry
With Typical Clipsal Lighting Load	TPWP2 - Battern, LED weatherproof	TPDL Series - LED Downlights	TPCL - Circular LED	TPFLS - LED Flood lights	TPDL Series - LED Downlights

									
PIR Motion Sensor Flush Mount Gimbal		Dual-Tech Occupancy Sensor		Microwave Sensor		PIR Sensor, Master DALI Output PIR Sensor, Slave		PIR Sensor Wide Range	
753CF1	753CF2	752/CD1RC	752/CD2RC	752HR2RC		752DALIRC (Master) 752DALIS (Slave)		752IR2RC	
Standalone		Standalone		Standalone		Standalone		Standalone	
220 - 240V, 50 / 60Hz		240Va.c. ±10% / 50Hz		220-240Va.c., 50 / 60 Hz		220-240Va.c., 50 / 60 Hz		220-240Va.c., 50 / 60 Hz	
3-Wire		3-Wire		3-Wire		3-Wire		3-Wire	
Simple, unobtrusive flush design, gimble head		Dual technology for high accuracy		Detection for highbays		Daylight harvesting, DALI broadcast outputs		Wide detection	
PIR		Dual (PIR and/or Ultrasonic)		High Frequency Dopler Effect		PIR		PIR	
IP20		IP20		IP40 (Flush) IP42 (Surface)		IP40 (Flush) IP42 (Surface)		IP40 (Flush) IP42 (Surface)	
Flush for false ceiling		Ceiling (Flush/Surface)		Ceiling (Flush/Surface)		Ceiling (Flush/Surface)		Ceiling (Flush/Surface)	
360°		360°		360°		360°		360°	
Ø 7m		PIR: Ø 8m US: 10x16m		Ø 10m at H = 5,5 - 10m Ø 14m at H = 2,5 - 5m		Ø 8m at H = 2.5m		Ø 30m	
30s -30min Pulse mode	Channel 1: 30 sec – 30 min Channel 2: 10 sec – 15 min	5 sec – 30 min	Channel 1: 5 sec – 30 min Channel 2: 10 sec – 60 min	Channel 1: 10 sec – 30 min, 1s pulse Channel 2: 10 sec – 60 min		1 - 60 min Pulse mode		Channel 1: ww 10 sec – 30 min, 1s pulse Channel 2: 10 sec – 60 min, 5s pulse	
YES		YES		YES		YES		YES	
NO		NO		Wood, glass, thin brick		NO		NO	
NO (use separate switch to load)		YES		YES		YES		YES	
NO		YES		YES		YES		YES	
NO	YES - via Control System Aux input (using Ch 2)	YES - via Control System Aux input (using Ch 2)	NO	YES - via Control System Aux input (using Ch 2)		NO		YES - via Control System Aux input (using Ch 2)	
240V, 4A max 100W LED SA Resistive motor: 100W		240V~8A		240V~10A / 5A		Load 1: 220-240 V~, 8A max, 100W LED Load 2: 100W Motor 5A res		Dual channel: Max. 25 DALI ballasts, - 16V d.c. , 50mA max. Load 1: 220-240 V~, 8A max, 100W LED Load 2: 100W Motor 5A res	
3 year		2 year		3 year		3 year		3 year	
Homes, small offices		Public conveniences, open plan offices, class rooms		Warehouses, gyms, hotel lobbies, staircases, carparks		Class rooms, conference rooms, lobbies, retail stores, offices		Lobby, warehouses, offices, corridors, function rooms	

System Sensors Selection Guide

				
	C-Bus Multi-Sensor, PIR, Light Level and IR Flush Ceiling Mount	C-Bus Multi-Sensor, PIR Light Level and IR Surface Mount	C-Bus Sensor PIR and Light Level Flush Ceiling Mount	C-Bus Sensor PIR and Light Level Surface Mount
Cat Number	5753PEIRL	5754ODPEIR	5753L	5754ODPE
Standalone or System Sensor	C-Bus System	C-Bus System	C-Bus System	C-Bus System
Supply Voltage	C-Bus	C-Bus	C-Bus	C-Bus
Special Feature	Native C-Bus Multi sensor for system based occupancy control & daylight harvesting	Native C-Bus Multi sensor for system based occupancy control & daylight harvesting	Native C-Bus PIR sensor for system based occupancy control & daylight harvesting	Native C-Bus PIR sensor for system based occupancy control & daylight harvesting
Sensor Technology	PIR / PE	PIR / PE	PIR / PE	PIR / PE
IP Rating	Indoor	Indoor	Indoor	Indoor
Mounting	Flush ceiling	Surface	Flush ceiling	Surface
Detection Angle	360°	360°	360°	360°
Detection Range	Ø 15m at H- 2.4m	Ø 10m at H- 2.4m	Ø 15m at H- 2.4m	Ø 10m at H- 2.4m
Timer Setting	1 second to 18 hrs, 12 mins, 15 secs (1 sec intervals)	1 second to 18 hrs, 12 mins, 15 secs (1 sec intervals)	1 second to 18 hrs, 12 mins, 15 secs (1 sec intervals)	1 second to 18 hrs, 12 mins, 15 secs (1 sec intervals)
Light Level Sensor	YES	YES	YES	YES
Material Penetration	NO	NO	NO	NO
Manual Override	YES	YES	YES	YES
IR Control	YES- C-Bus IR remote control	YES- C-Bus IR remote control	NO	NO
Connectivity	Can control C-Bus connected loads	Can control C-Bus connected loads	Can control C-Bus connected loads	Can control C-Bus connected loads
Output Ratings	C-Bus	C-Bus	C-Bus	C-Bus
Design	C-Bus	C-Bus	C-Bus	C-Bus
Warranty	2 year	2 year	2 year	2 year
Suggested Application	Commercial, Residential, install flush into ceiling	Commercial, Residential, install onto ceiling or slab surface	Commercial, Residential, install flush into ceiling	Commercial, Residential, install onto ceiling or slab surface
With Typical Clipsal Lighting Load	N/A	N/A	N/A	N/A

			
C-Bus PIR Occupancy Sensor Outdoor	C-Bus PIR Occupancy Sensor Corner Mount	DALIcontrol PIR Motion Sensor 30 Series Mechanism	DALIcontrol Motion Sensor Flush Ceiling Mount
5750WPL-GY	5751L-WE	DCDAL31MOD	DCDALMS360
C-Bus System	C-Bus System	DALIcontrol System	DALIcontrol System
C-Bus	C-Bus	DALI	DALI
Native C-Bus PIR sensor for system based occupancy control	Native C-Bus PIR sensor for system based occupancy control	Native DALIcontrol PIR sensor for system based occupancy control	Native DALIcontrol Multi sensor for system based occupancy control & daylight harvesting
PIR	PIR	PIR	PIR
IP66	Indoor	Indoor	Indoor
Surface	Surface	Grid plate or ceiling housing	Flush
110°	90°	120°	360°
up to 18 metres from the unit at H- 2.4m	6m x 6m at H- 2.4m	Ø 5m at H- 2.7m	Ø 10m at H = 2.4m
1 second to 18 hrs, 12 mins, 15 secs (1 sec intervals)	1 second to 18 hrs, 12 mins, 15 secs (1 sec intervals)	1 min to 255 mins	1 min to 255 mins
YES	YES	NO	YES
NO	NO	NO	NO
YES	YES	YES	YES
NO	NO	NO	NO
Can control C-Bus connected loads	Can control C-Bus connected loads	Can control DALI connected loads	Can control DALI connected loads
C-Bus	C-Bus	DALI	DALI
C-Bus	C-Bus	DALI	DALI
2 year	2 year	2 year	2 year
Commercial, Residential, install onto ceiling or slab surface or wall	Commercial, Residential, install onto ceiling or slab surface or wall	Commercial, install into 30M grid plates or DALIcontrol ceiling housing	Commercial, install flush into ceiling
N/A	N/A	N/A	N/A

Life Is On



Schneider Electric (Australia) Pty. Ltd.

33-37 Port Wakefield Road, Gepps Cross, South Australia, 5094
PO Box 132, Enfield Plaza, South Australia, 5085

clipsal.com

Consumer Support Enquiries

Phone: 1300 669 925

Website: clipsal.com/contactus

National Customer Care (trade only)

Phone: 1300 369 233

Email: plugin@clipsal.com.au

April 2022

©2022 Schneider Electric. All Rights Reserved.

Schneider Electric | Life Is On, EcoXpert, and Clipsal are trademarks and the property of Schneider Electric SE, its subsidiaries, and affiliated companies. All other trademarks are the property of their respective owners. 988-21944520