

ALKALINE-MANGANESE DIOXIDE BATTERY

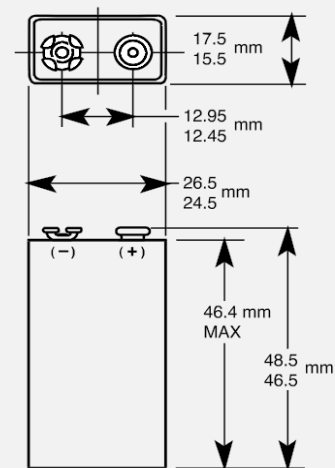

size: 9V (6LR61) PC1604



Dimensions shown are IEC standards

KEY FEATURES

- Reliable Performance
- Excellent resistance to corrosion
- Designed to meet all major quality, safety and environmental standards:
 - Safety: IEC 60086-5
 - ANSI C 18.1M, Part-2
 - EU Battery Directive
 - Quality: ISO 14001 and 9001, Duracell World Class Continuous Improvement Program

TYPICAL APPLICATIONS

- Carbon Monoxide Detectors
- Smoke Detectors
- Multimeters
- Medical Devices
- Microphones

ELECTRICAL CHARACTERISTICS

- Nominal capacity (2 mA Cont., 5V cut-off) 673 mAh
- Typical Voltage (at + 20 °C) 9 V
- AC Impedance @ 1kHz 1,700 mΩ

PHYSICAL CHARACTERISTICS

- Typical weight 45.0 g (1.6 oz)
- Typical volume 22.8 cm³ (1.4 in³)
- Terminals Miniature snap

OPERATING & STORAGE CONDITIONS

- Operating temperature range -20°C to 54°C (-4°F to 130°F)
- Recommended Storage (storage area should be clean, cool, dry and ventilated) 5°C to 30°C (41°F to 86°F)

TYPICAL PERFORMANCE

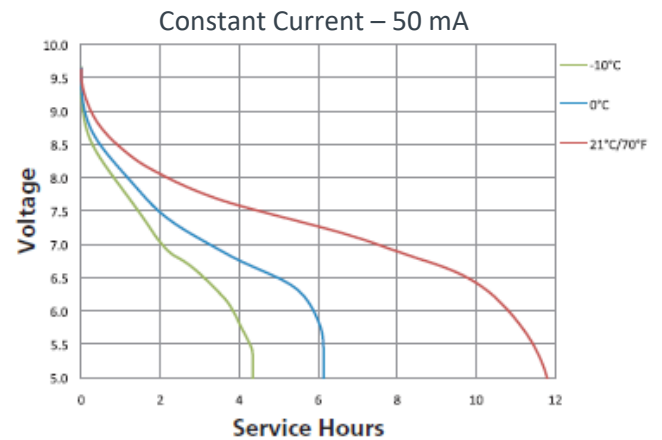
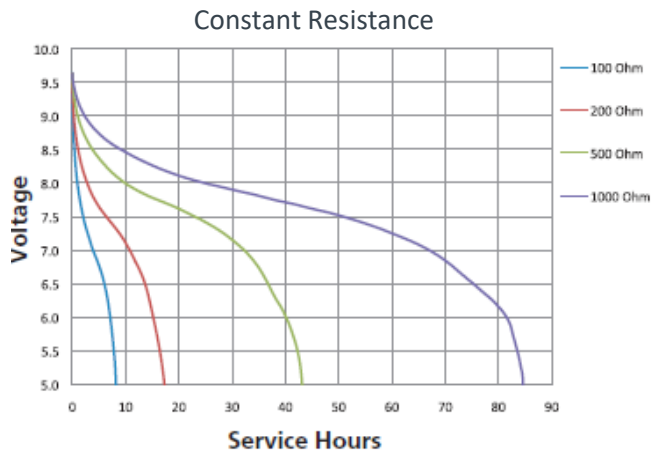
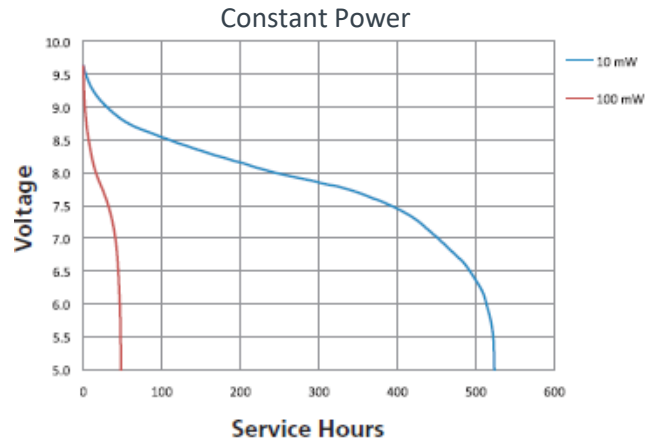
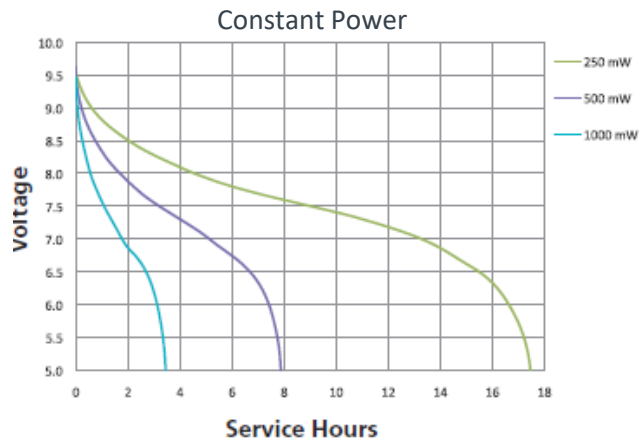
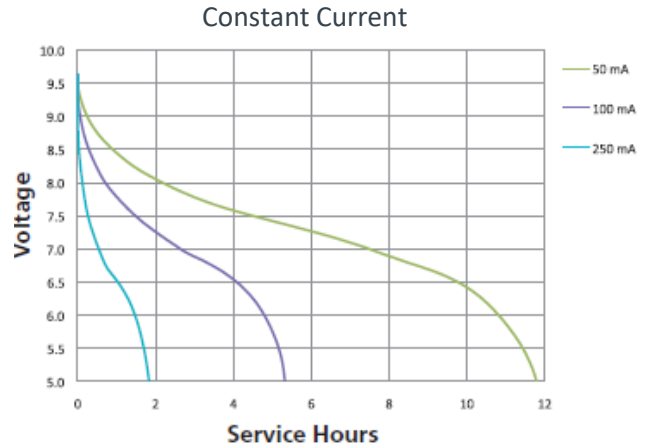
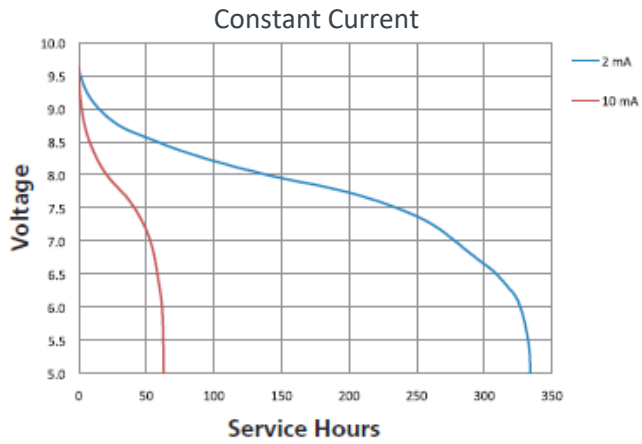

Delivered capacity is dependent on the applied load, operating temperature and cut-off voltage. Please refer to the charts and discharge data shown for examples of the energy/service life that the battery will provide for various load conditions.

This data is subject to change. Performance information is typical. Contact Duracell for the latest information.