



OPAL LGS8TC - 8W

8 watt LED SMD GLS style opal lamps, with selectable colour temperature

Application

Energy efficient LED lamp solutions

Design Specifications

- Opal polycarbonate diffuser, beam distribution 200 degree
- Poly covered aluminium body, B22 and E27 lamp bases
- High efficiency SMD LED chips, CRI>80
- Integral non-dimmable LED driver
- Colour temperature selectable 2700K/4000K/6000K
- 1:1 size to traditional GLS / A60 lamp, suits most GLS / A60 lamp fittings, double insulation



Technical Specification

Model No.	Input Voltage (V/AC)	Power (W)	Lumens (lm)	CCT (K)	CRI	Beam Angle (°)
LGS8TC/B22	240	8	700/750/700	2700/4000/6000	80	200
LGS8TC/E27	240	8	700/750/700	2700/4000/6000	80	200

Model No.	Dimmable	Diameter (mm)	Length (mm)	Base Type
LGS8TC/B22	NO	60	112	B22
LGS8TC/E27	NO	60	112	E27

IMPORTANT, where CCT selection switching is provided, it is important to switch OFF the SUPPLY before the CCT selection is made, otherwise equipment damage may occur.



Due to continued product and technology enhancements, data sourced from sal.net.au shall not form part of any contract and or technical performance guarantee unless expressly confirmed in writing by SAL at the time of order. Products are sold in accordance with [SAL Terms and Conditions of sale](#) and all images shown are for illustration purposes only and may vary from the actual colour or finish. Unless specifically stated, all IP ratings nominated for Interior products are from "below the ceiling".

Dimensions

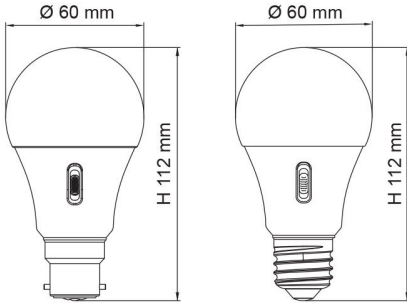

THE SFI SYSTEM ELIMINATES LED FLICKERING.

**SIMPLY
MATCH THE
UNIFIT SFI
DOWNLIGHT
WITH THIS
SDD400SFI
DIMMER.**



**DIM with
FLICKER
CONTROL**

For related
products
please
scan me

